

MCU

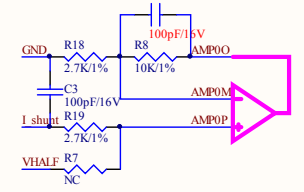
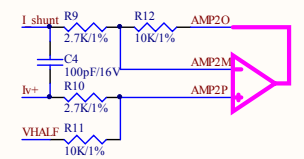
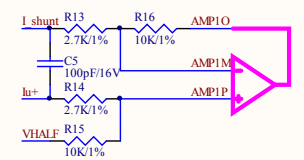
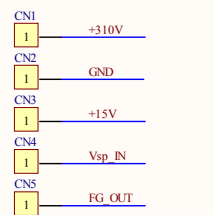
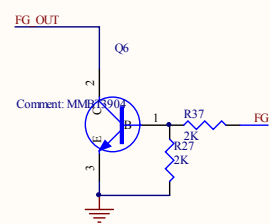
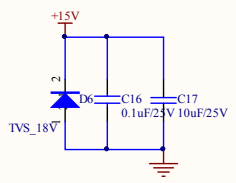
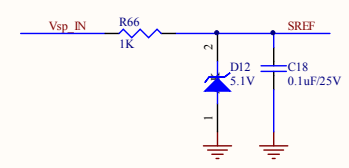
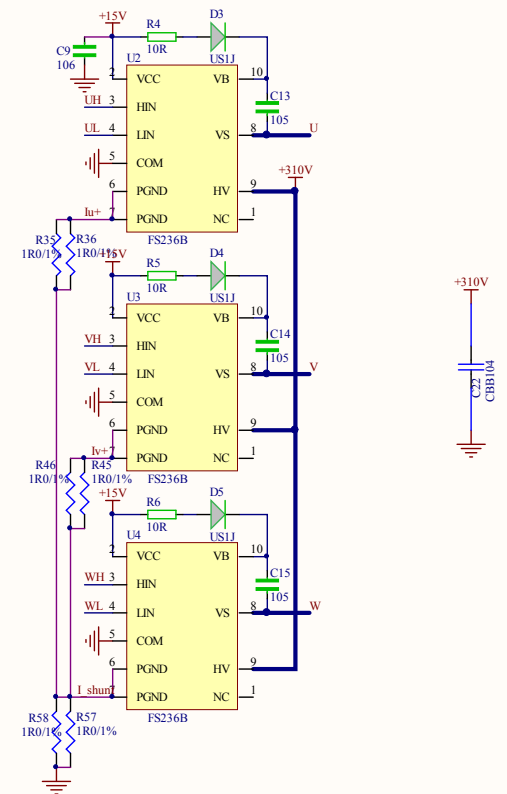
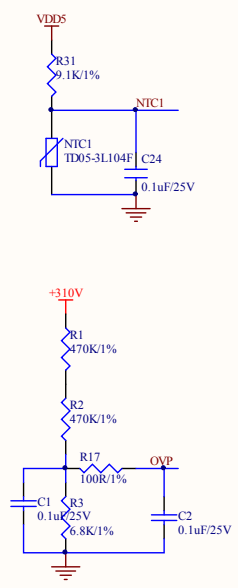

方案名称: FU6812P+FS236-室内风机	设计电压: DC310V
设计人: Gavin	设计功率: 30W
设计日期: 2020-06-20	版本号: V1.0
审核人: Frank	备注:
审核日期: 2020-06-29	